

1T9063EL | FORTYEIGHT Label 6

Low voltage adjustable LED professional projector

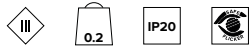

	4000K	H(m)	D(m)	Emax(lx)
	Ra90		41°	
Fixture Power	15W	1	0.75	3494
Source Flux	2018lm	2	1.50	873
Fixture Flux	1727lm	3	2.24	388
Efficacy	115lm/W	4	2.99	218
TS1976	Imax=1767cd/klm	Imax	3567cd	5
			3.74	140

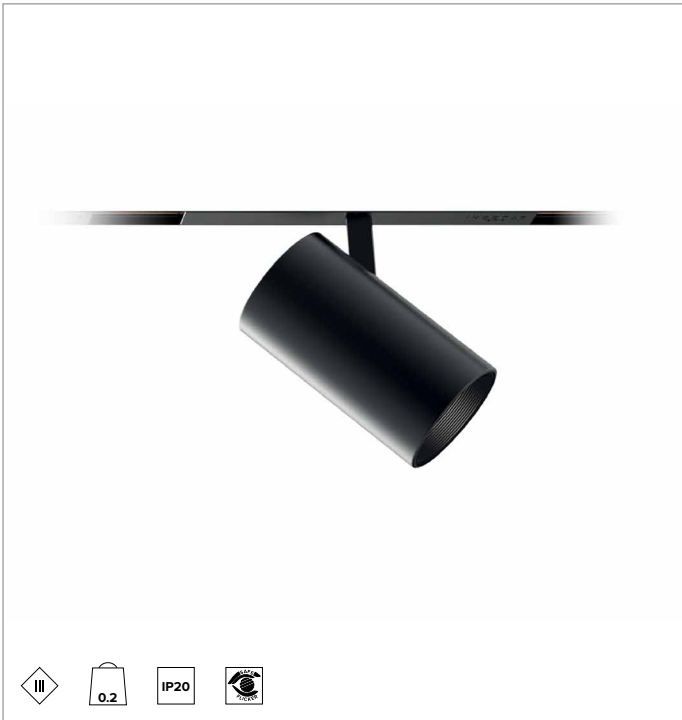
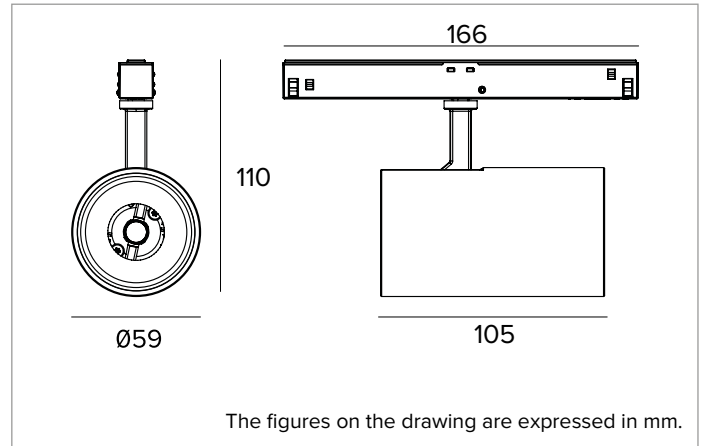

SOURCE

High efficiency Chip on Board LED Ra90. 3500K on request.

Energy efficiency class: E

Nominal power: 14W

Nominal flux: 2018lm

Colour rendering index: 90

Rf: 90

Rg: 98

CCT nominal: 4000K

SDCM: 1.5

Lifetime (L80/B10): >50000h tq +25°C

ILLUMINOTECHNICAL CHARACTERISTICS

MWFL - precision optics with a black silicone cut off ring. Version with a transparent PMMA lens.

Optic: LENS

Beam angles: MWFL

Optical efficiency: 86%

Fixture flux: 1727lm

Luminous efficacy: 115lm/W

Photobiological safety: Compliant with RG1 low risk group

MECHANICAL CHARACTERISTICS

Painted die-cast aluminium body. The optical unit can be adjusted from 0° a 90° on the vertical plane and 360° on the horizontal plane with friction locking system.

Colour and finish: Deep black

Dimensions: D=59mm

Weight: 0.2Kg

Version: ON-OFF

Degree of protection: IP20

ELECTRICAL CHARACTERISTICS

Electronic ON-OFF power supply for track.

Fixture Power: 15W

Power supply: 48Vdc

Insulation Class: CLASS 3

Class F: YES

SAFE FLICKER: PstLM=<1 and SVM=<0.4 (IEC TR 61547-1 and IEC TR 63158), to ensure a more comfortable and safe light

Ambient temperature: 0°C / +25°C

INSTALLATION

Quick coupling system for mounting the product on the track.

NOTES

Not polarized fixture. The arm is and the adapter are supplied in the same colour as the body of the projector. 110-277Vac version available on request.

WARRANTY

5 years.

WARNING

Luminaire designed for disposal/recycling at end-of-life. Replaceable (LED only) light source by a professional. Replaceable control gear by a professional.

Due to the technological evolution of the electronic components, the data provided may be updated, and as such, confirmation must be requested during the order process.

Luminous flux and power supply have +/-10% tolerances with respect to the indicated value. tq +25°C (CIE 121).

We reserve the right to make technical changes.

Targetti Sankey S.r.l.
Via Pratese, 164
50145 Firenze - Italy
Tel: +39 055 37911
targetti.com
targetti@targetti.com

CCIAA Firenze
Share Capital:
€ 500.000,00
VAT N. (IT):
01537660480
R.E.A: FI-275656

TARGETTI

1T9063EL | FORTYEIGHT Label 6

Low voltage adjustable LED professional projector

Accessories

Filter



Ø mm	Code
50	1T4721

PMMA holographic filter with blade effect to ovalize the light beam; more evident when combined with spot and flood optics.

Due to the technological evolution of the electronic components, the data provided may be updated, and as such, confirmation must be requested during the order process.

Luminous flux and power supply have +/-10% tolerances with respect to the indicated value. tq +25°C (CIE 121).

We reserve the right to make technical changes.

Targetti Sankey S.r.l.
Via Pratese, 164
50145 Firenze - Italy
Tel: +39 055 37911
targetti.com
targetti@targetti.com

CCIAA Firenze
Share Capital:
€ 500.000,00
VAT N. (IT):
01537660480
R.E.A: FI-275656

TARGETTI